



Metal ceilings

 custom size

MS1000XX
CORRIDOR 1000
system

 **CBI**
EUROPE
HI-TECH INTERIORS

MS1000XX CORRIDOR 1000 SYSTEM



CUSTOM SIZE

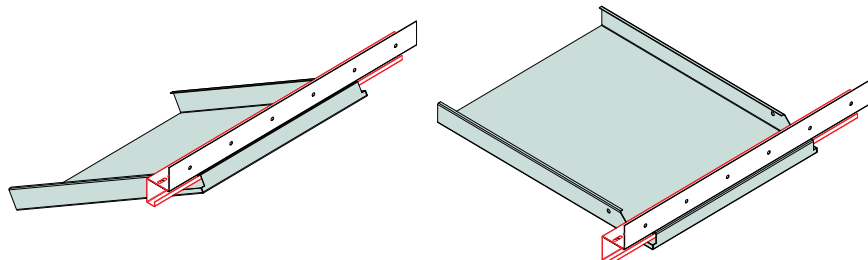
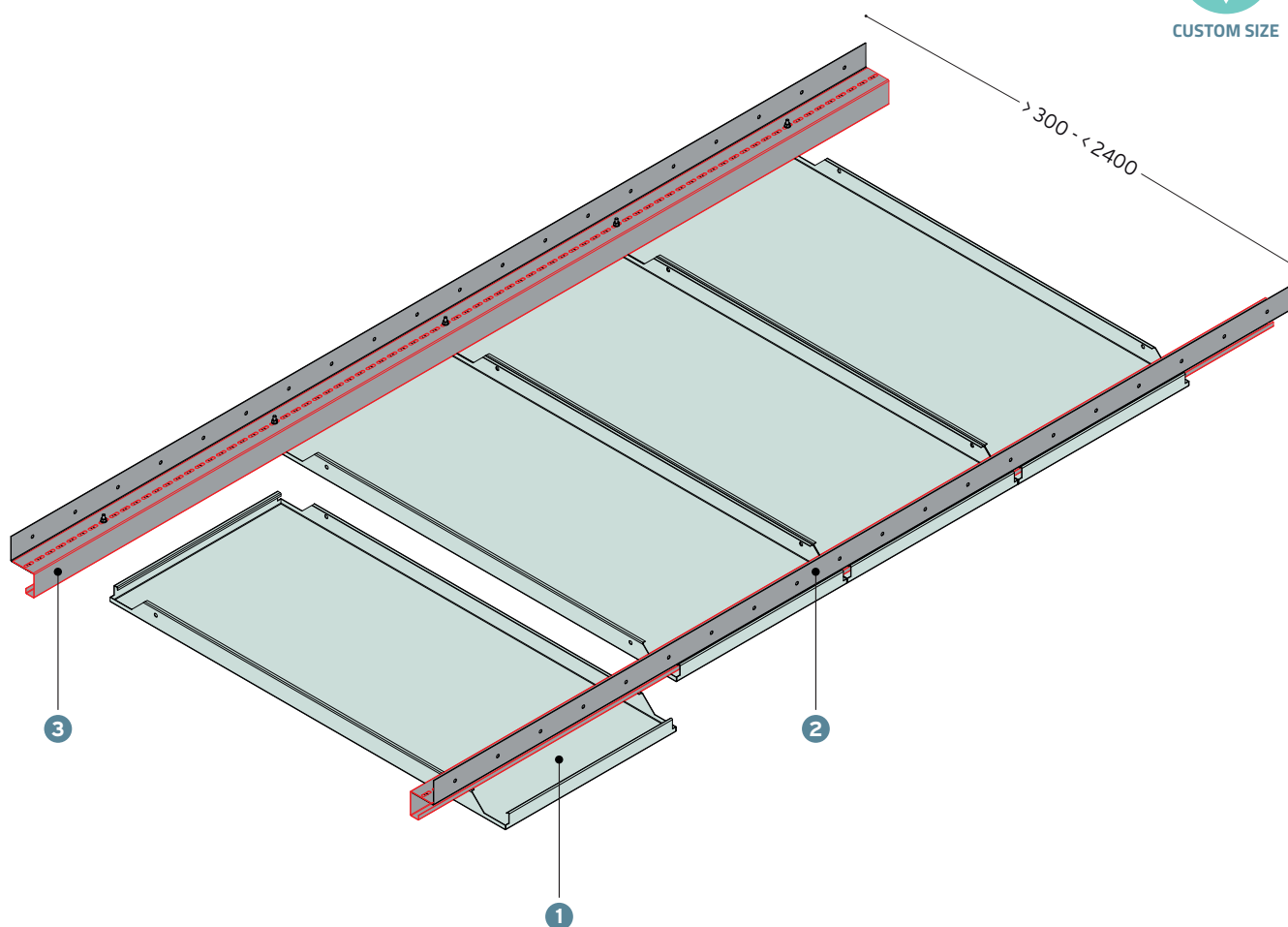

1

MS1000XX panel
pannello

2

CPA1000 primary angle
moulding
angolare primario

3

P1000 main runner profile
profilo portante

GU600 1.5 mm gasket to hide edges
guarnizione autoadesiva di 1.5 mm
per il mascheramento degli spigoli
(optional)



MS1000XX square edge
bordo angolo vivo



CUSTOM SIZE

aluminium alluminio 0.6 mm > 1 mm
steel acciaio 0.5 mm > 1 mm

width larghezza 300 mm > 600 mm
length lunghezza 600 mm > 2400 mm

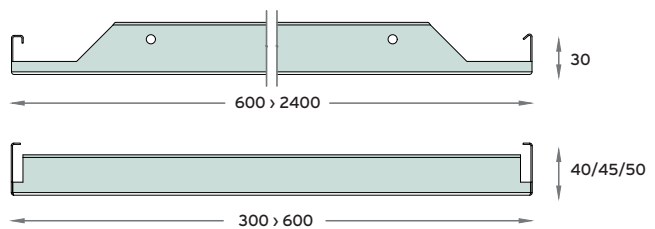
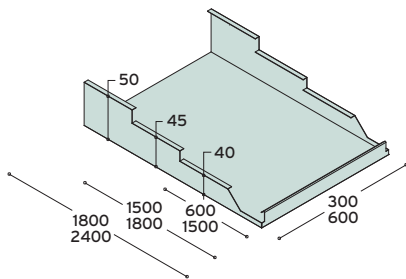
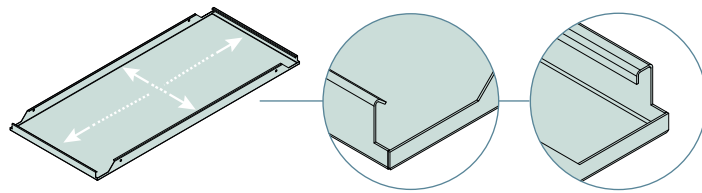

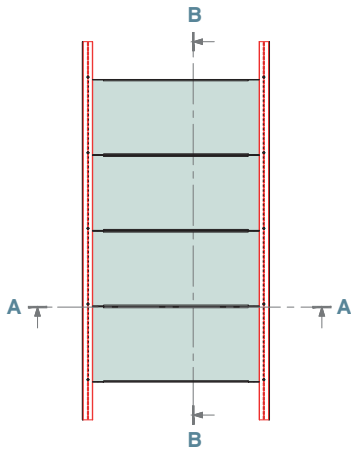

SEZ. A-A

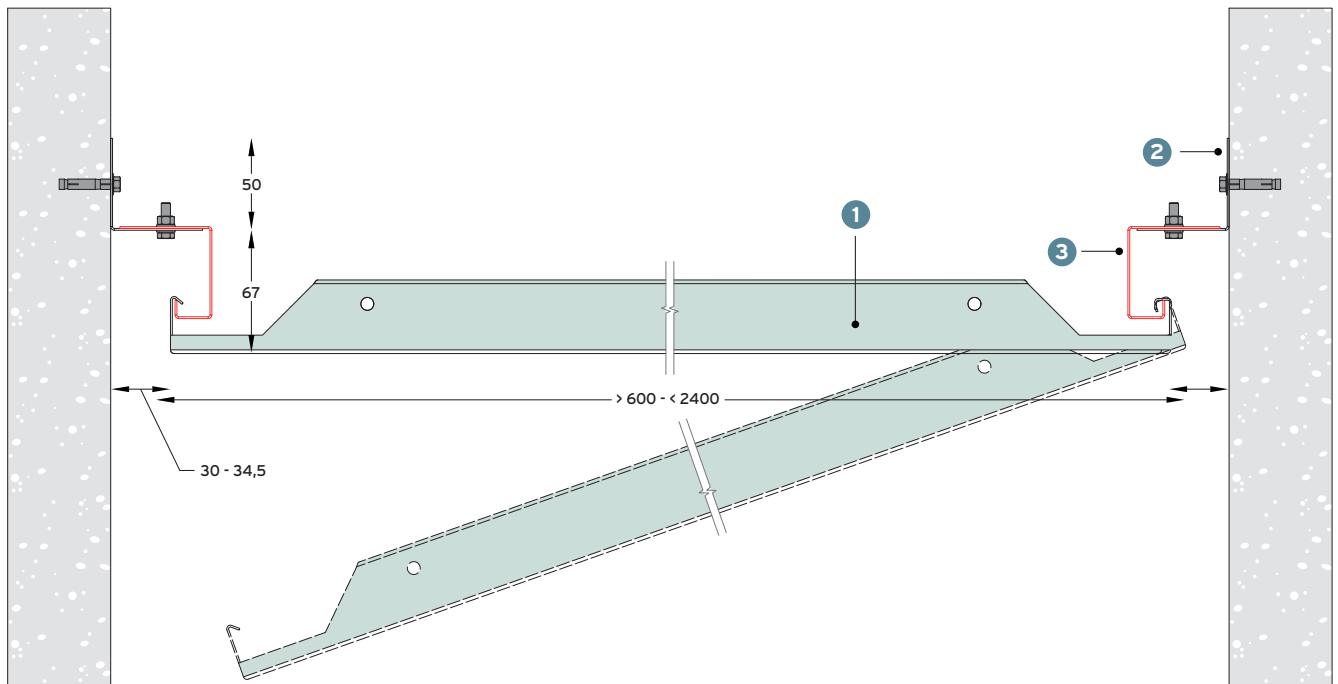

SEZ. B-B

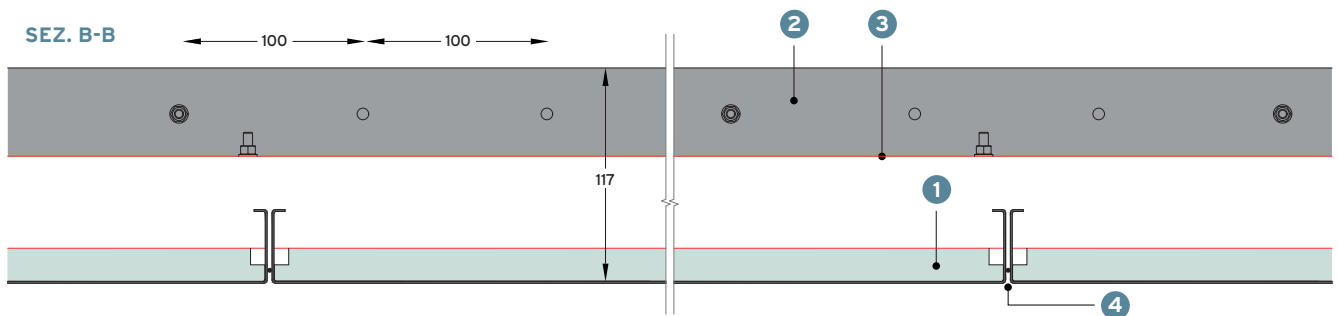

1	2	3	4
MS1000XX pannello	CPA1000 primary angle moulding angolare primario	P1000 main runner profile profilo portante	GU600 1.5 mm gasket to hide edges guarnizione autoadesiva di 1.5 mm per il mascheramento degli spigoli (optional)

PERFORATION PANELS

standard width < 600 mm

● ■ perforation

MICRO PERFORATIONS

AP0/1

Ø 0.7 mm = 1,70% - parallel pitch 5 mm

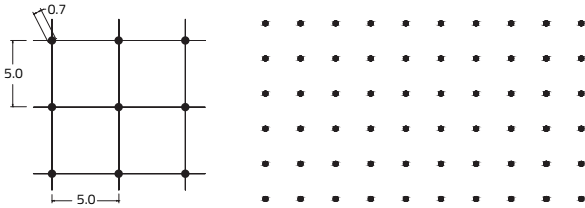

AP0/2

Ø 0.7 mm = 0,46% - parallel pitch 10 mm

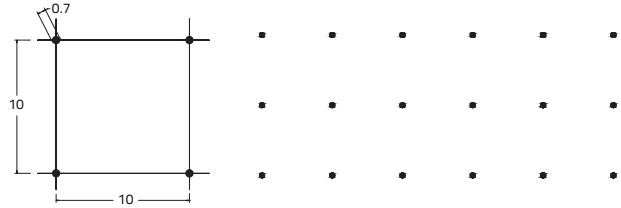

AP1

Ø 1.5 mm = 12% - diagonal pitchn 4.5 mm

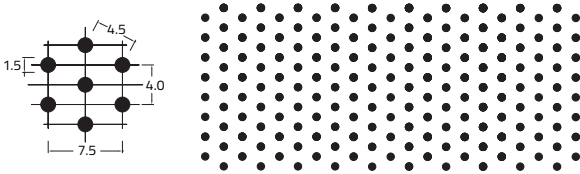

AP1/0

Ø 1.5 mm = 22% - diagonal pitch 4 mm

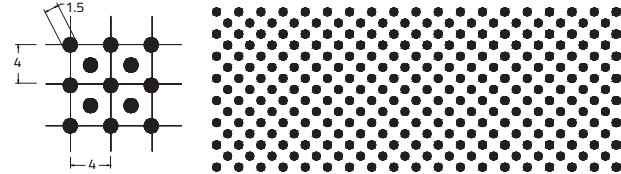

STANDARD PERFORATIONS

AP2

Ø 2.5 mm = 16% - parallel pitch 5.5 mm

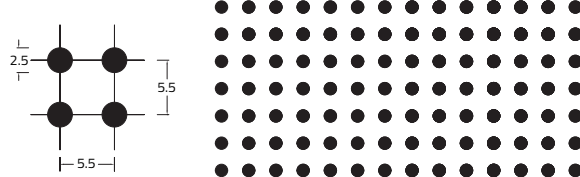

AP3

Ø 2.0 mm = 25% - diagonal pitch 3.5 mm

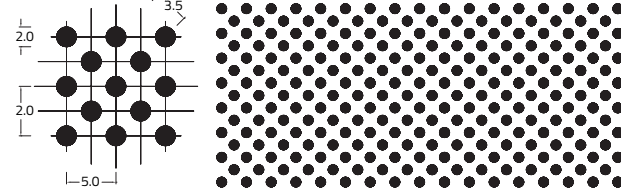

AP4

Ø 2.0 mm = 12.5% - parallel pitch 5 mm

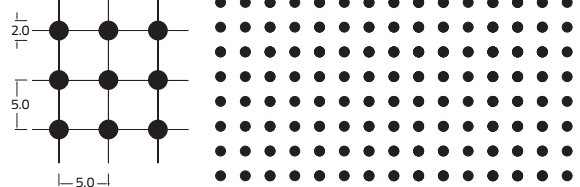

AP5

Ø 2.5 mm = 4% - parallel pitch 11 mm

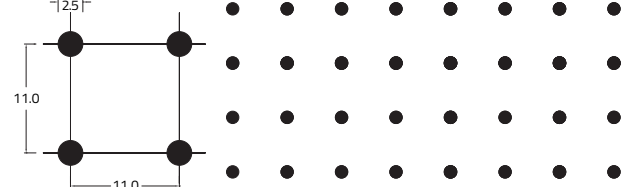

AP6

Ø 2.0 mm = 3% - parallel pitch 10 mm

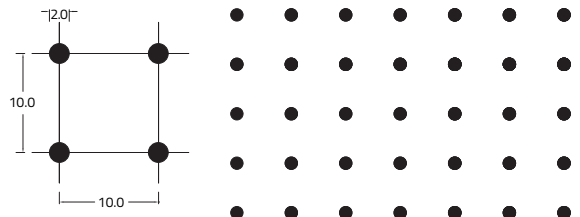

APQ

5 x 5 mm = 25% - parallel pitch 5 mm

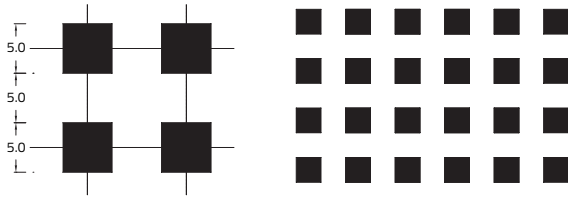

APQ1

10 x 10 mm = 25% - parallel pitch 10 mm

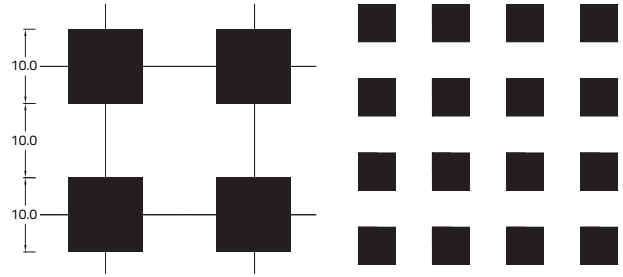

APQ2

2 x 2 mm = 4.5% - parallel pitch 9.5 mm

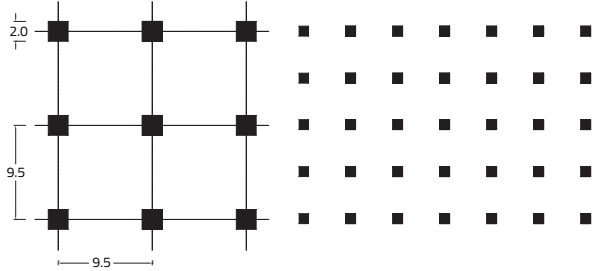

APQ3

2 x 2 mm = 1.1% - parallel pitch 19 mm

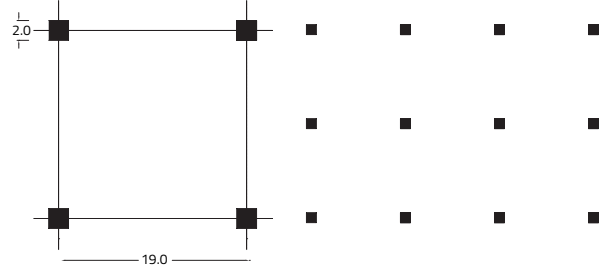

APQ4

3 x 3 mm = 19% - parallel pitch 7 mm

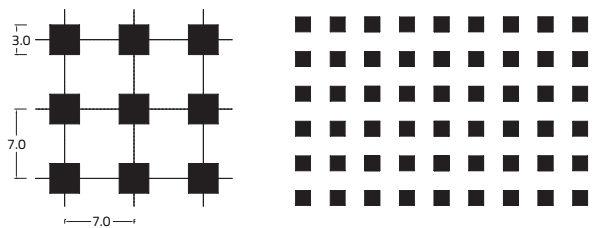

APQ5

3 x 3 mm = 9.5% - parallel pitch 14 mm

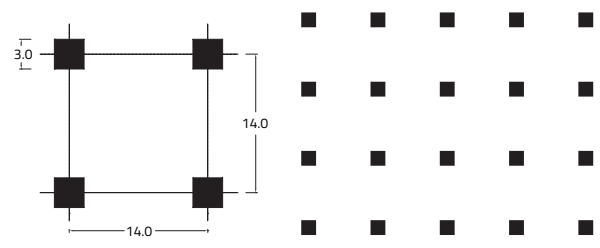

special width > 600 mm

AP7

Ø 2.5 mm = 16% - parallel pitch 5 mm

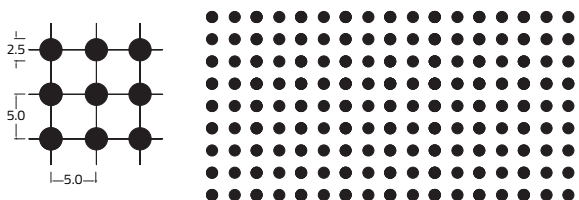

AP8

Ø 3.5 mm = 12% - parallel pitch 9 mm

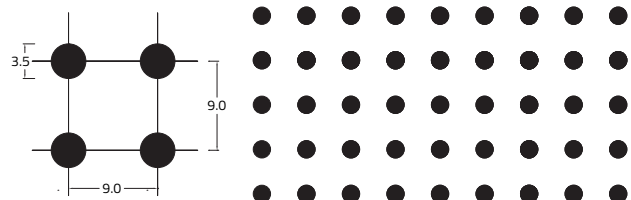

AP9

Ø 3.0 mm - parallel pitch 6 mm

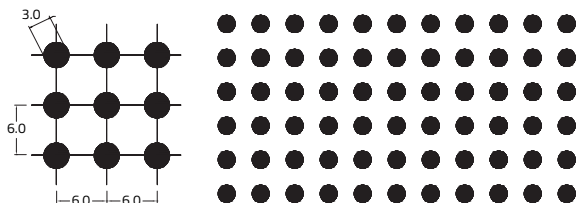

AP10

Ø 3.0 mm - parallel pitch 6 mm

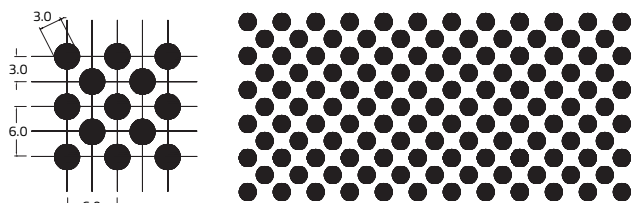

PERIMETRAL MOLDING

standard length 3000 mm For special dimension perimetral moldings are available

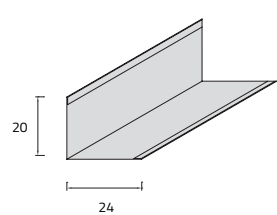
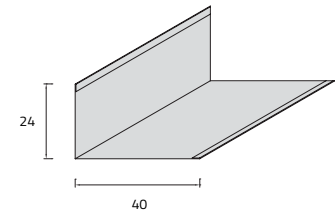
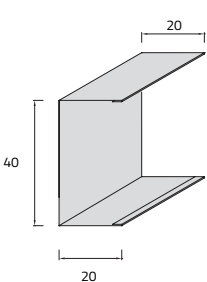
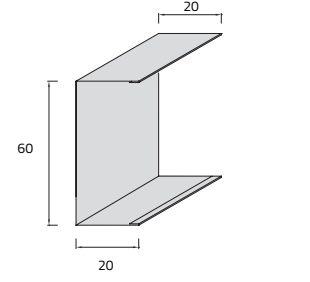
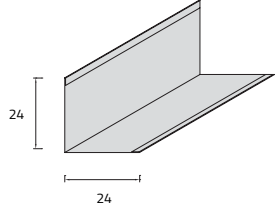
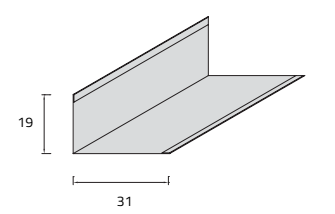
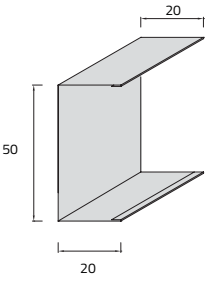
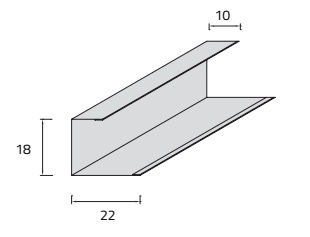
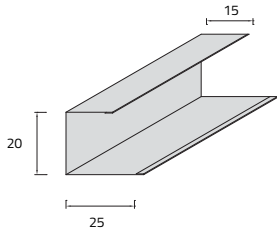
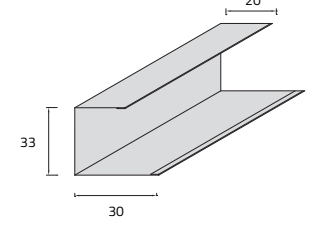
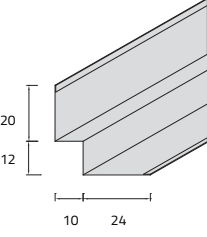
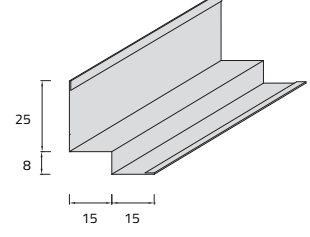
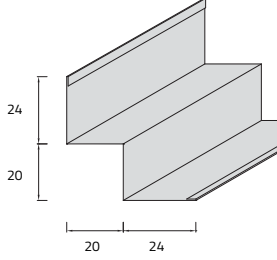
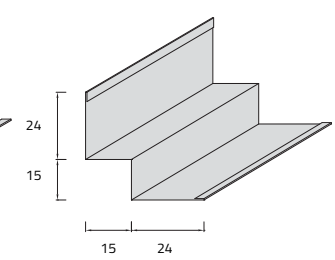
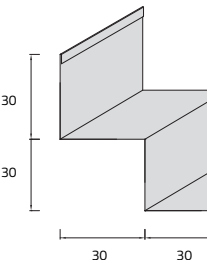
 <p>20 X 24</p>	 <p>24 X 40</p>	 <p>24 X 40 X 20</p>	 <p>20 X 60 X 20</p>
<p>CP10 aluminum 0.5/0.6 mm A3000 steel 0.5/0.6 mm</p>	<p>CP20 aluminum 0.5/0.6 mm A3002 steel 0.5/0.6 mm</p>	<p>CU4020 aluminum 0.5/0.6 mm U3000 steel 0.5/0.6 mm</p>	<p>CU6020 aluminum 0.5/0.6 mm U3002 steel 0.5/0.6 mm</p>
 <p>24 X 24</p>	 <p>19 X 31</p>	 <p>20 X 50 X 20</p>	 <p>10 X 18 X 22</p>
<p>CP11 aluminum 0.5/0.6 mm A3001 steel 0.5/0.6 mm</p>	<p>CP30 aluminum 0.5/0.6 mm A3003 steel 0.5/0.6 mm</p>	<p>CU5020 aluminum 0.5/0.6 mm U3001 steel 0.5/0.6 mm</p>	<p>CU1822 aluminum 0.5/0.6 mm U3003 steel 0.5/0.6 mm</p>
 <p>15 X 20 X 25</p>	 <p>20 X 33 X 30</p>	 <p>20 X 12 X 12 X 24</p>	 <p>25 X 8 X 15 X 15</p>
<p>CU2025 aluminum 0.5/0.6 mm U3004 steel 0.5/0.6 mm</p>	<p>CU3330 aluminum 0.5/0.6 mm U3005 steel 0.5/0.6 mm</p>	<p>CW1210 aluminum 0.5/0.6 mm W3000 steel 0.5/0.6 mm</p>	<p>CW0815 aluminum 0.5/0.6 mm W3002 steel 0.5/0.6 mm</p>
 <p>24 X 20 X 20 X 24</p>	 <p>24 X 15 X 15 X 24</p>	 <p>30 X 30 X 30 X 30</p>	
<p>CW2020 aluminum 0.5/0.6 mm W3003 steel 0.5/0.6 mm</p>	<p>CW1515 aluminum 0.5/0.6 mm W3004 steel 0.5/0.6 mm</p>	<p>CW3030 aluminum 0.5/0.6 mm W3005 steel 0.5/0.6 mm</p>	



ACOUSTIC ABSORPTION PANELS

test: Istituto Giordano n° 196088
197140 UNI EN ISO 354: 2003

PLAIN NOT PERFORATED

HZ	100	250	500	1000	2000	4000
RI[DB]	9,8	17,3	23,1	29,1	35,0	40,8
RIFERIMENTO [DB]	8	20	27	30	31	-

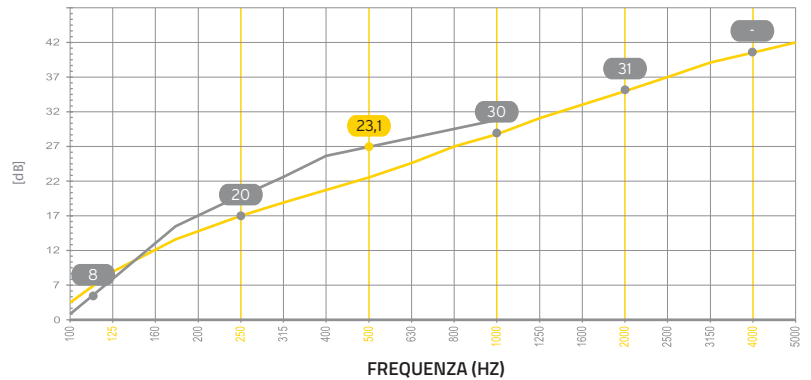

AP2 PERFORATION

hole ϕ 2.5 mm
perforated area 16%
block fire-prof non-wovens 60 gr/m²

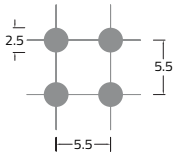

α_s 0.31 | 0.77 | 0.78 | 0.83 | 0.82 | 0.73 $\alpha_w = 0.85$

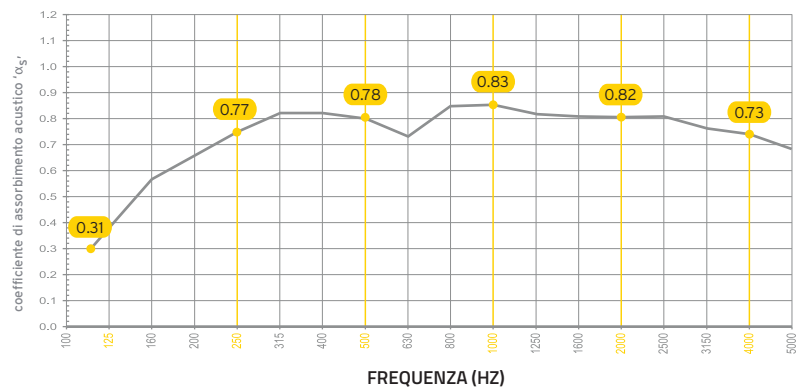

AP3 PERFORATION

hole ϕ 2.0 mm
perforated area 25%
block fire-prof non-wovens 60 gr/m²

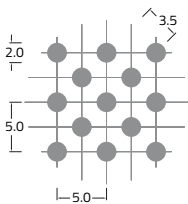

α_s 0.30 | 0.76 | 0.78 | 0.85 | 0.85 | 0.79 $\alpha_w = 0.85$

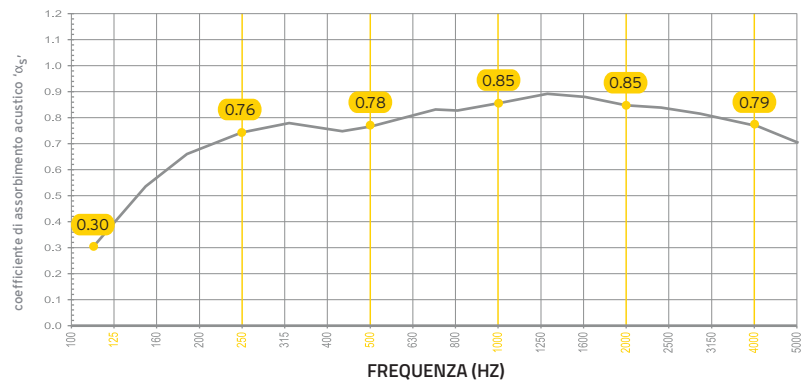

COLOURS RANGE

STEEL / ALUMINIUM



white



RAL 9006
silver



RAL 7024
dark grey



RAL 9005
black



satin-finish aluminium

POWDER COATED



ALL RAL COLOURS

WOOD



SL57
whitened oak



SL56
cherry tree



SL252
winchester



SL02
light oak



SL302
dark oak



SL55
wenge

ALUMINIUM / MAT



RAL 1015
ivory



RAL 1001
beige



RAL 1021
cadmio yellow



RAL 1007
chrome yellow



RAL 2004
orange



RAL 3002
carmine red



navy blue



RAL 5017
blue



RAL 6018
pea green

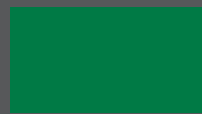

RAL 6029
mint colour

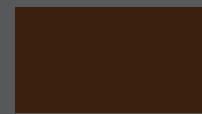

RAL 8014
brown

ALUMINIUM / BRIGHT



aisi steel
310



brass yellow
330



gold
260

The range of colours shown on this page is purely indicative, and we recommended that you request the samples. For other colours, please ask about the availability in stock.

For further details, refer to the bundle of RAL colours and CBI's exclusive colours bundle, or contact the technical department at CBI Europe.

METAL CEILINGS & COVERINGS: technical perfection, 100% made in Italy.

CBI Europe's Metal Ceilings and Coverings systems are made up of modular elements (panels, strips or grilles) and suspended by steel support structures. Elements are **standard or custom made**, resistant, durable,

easy to handle, simple and quick to install, inspected, certified, eco-friendly and designed for new generation interiors, thanks to the architectural elements of great aesthetic versatility.



AESTETICH VERSATILITY



LIMITLESS CONFIGURATION

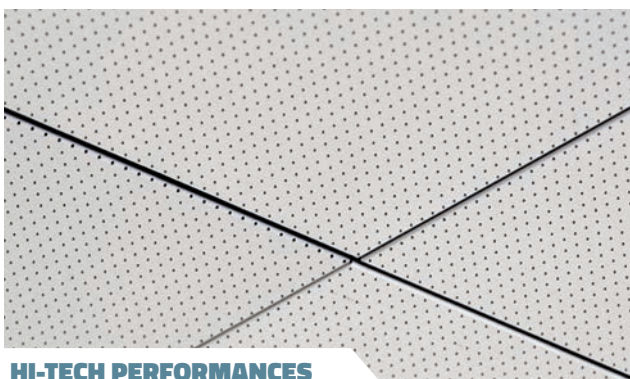

HI-TECH PERFORMANCES

Why

VERSATILE, FUNCTIONAL, LONG LASTING AND EASY TO INSTALL: A PERFECT COMBINATION OF TECHNOLOGY AND DESIGN THAT GUARANTEES HYGIENE AND STRENGTH.

Where

LARGE PUBLIC SPACES - HALLS, SHOPPING CENTRES, AIRPORTS, BANKS, OFFICES, CORRIDORS, STERILE ENVIRONMENTS, THEATRES, CANTEENS, HOSPITALS - OUTDOORS AND INDOORS.

Benefit

- **ACHIEVING FLEXIBLE, COMFORTABLE, CONTEMPORARY AND RESPONSIBLE INTERIORS.**
- **OBTAINING POINTS FOR LEED CERTIFICATION.**
- **SOUNDPROOFED ENVIRONMENTS.**
- **SPEEDING UP CONSTRUCTION.**
- **CONTAINING COSTS OF LABOUR AND MAINTENANCE.**
- **STRUCTURES 100% INSPECTABLE.**
- **INTEGRATION WITH ADVANCED CLIMATE CONTROL, DOMOTICS AND LIGHTING.**
- **PRECISE BUDGETING.**



FIRE REACTION

Including versions incorporating sound-absorbing non-woven fabric, are non-flammable according to the Italian Ministerial Decree of the 15th march 2005, and therefore conform to Euroclass A1 fire reaction requirements (only for not perforated panels).



HYGIENE

Easy to wash and sterilise. On request, they can also be supplied in a special fungicidal and bactericidal paint finish. We recommend hermetically sealed, Down Clip 200 System Metal Ceilings for use in operating theatres and pharmaceutical industries. All other types of metal suspended ceilings are ideal for use in kitchens, canteens, hospitals and schools. They also provide valuable protection against dust in industries producing delicate electronic circuits. Tests carried out under ISO 22196 ensure the reduction of the microbial population > 95% after 24 hours.



HUMIDITY RESISTANCE

Maintain their dimensional stability even under extreme ambient conditions, and can therefore be installed in environments characterised by high levels of relative humidity and large variations in temperature. For outdoor installations, please contact CBI Europe's Technical Department.



PAINTWORK

Suspended ceilings in pre-painted aluminium and hot-galvanised and pre-painted FePO2 steel are coil-coated with primer and polyester paint to a thickness of 25 microns. Suspended ceilings in electro-galvanised and post-painted FePO2 steel are electrostatically coated with resin based, thermosetting, polyester powder paints to a thickness of 60 microns.



LIGHT REFLECTANCE

All metal suspended ceilings finished in white and unperforated > 85% have a standard gloss level of 20.



INTEGRATED ACCESSORIES

All metal suspended ceilings can be fitted with accessories such as lighting units, ventilation vents, smoke detectors, sprinklers and suspended signage



FASTNESS

The systems are designed to guarantee rapid installation, speeding up the installation phases and respecting all the requirements of planarity and orthogonality.



ACOUSTIC ABSORPTION

Ceilings and coverings combine acoustic performance, comfort and aesthetics with adequate absorption values. Upon request they can be supplied with certifications issued by independent companies.



LEED CERTIFICATION

All products are manufactured in certified and constantly monitored processes to guarantee the highest standards of quality and safety.



ANTI-SEISMIC

The systems guarantee the application of all good safety practices in the construction and development of dedicated projects. Upon request, they can be supplied with an anti-seismic reports, which indicate suitable bracing.